

FITTING INSTRUCTION

Clamp mark in acc. with		Cables joining
ISO	PN	
1	L	Left directional lights
2	+	Rear fog lights
3	31	Ground
4	R	Right directional lights
5	58R	Right side parking lights
6	54	Stoplights
7	58L	Left side parking lights

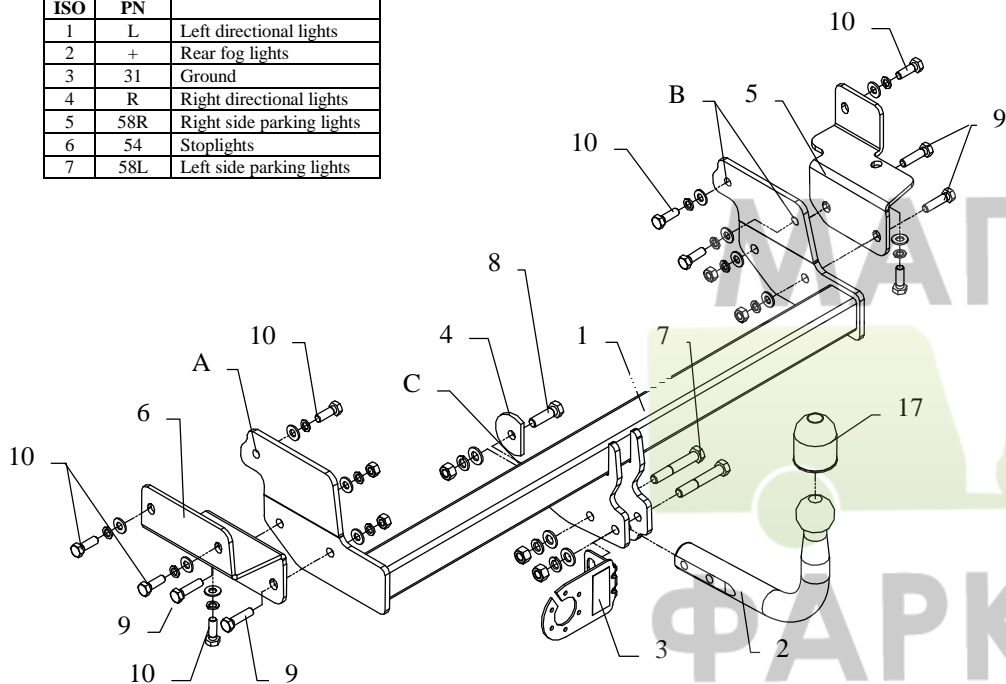

The instruction of the assembly

1. Put towbar to chassis member in that way so holes (pos. A and B) agree to holes in chassis members and screw it using bolts M10x1,25x30 mm (pos. 10) (fix loosely).
2. To the left chassis member put element (pos. 6) and screw it using bolts M10x1,25x30 mm (pos. 10) and M10x40 mm (pos. 9) – see drawing.
3. To the right chassis member put element (pos. 5) and screw it using bolts M10x1,25x30 mm (pos. 10) and M10x40 mm (pos. 9) – see drawing.
4. Trough hole (pos. C) screw with original tow handle – use element (pos. 4) and bolt M12x50 mm (pos. 8) – see drawing.
5. Screw tow-ball (pos. 2) and socket plate (pos. 3) using bolts M12x75 mm (pos. 7) from equipment .
6. Tighten all bolts according to the torque shown in the table.
7. Connect electric wires of 7-poles socket according to the instruction of the car. (Recommend to make at authorized service station)
8. Complete paint layer damaged during installation.

This towbar is designed to assembly in following cars:
MITSUBISHI LANCER ESTATE produced since 06.2003 till 2008,
 catalogue no. **Z30** and is prepared to tow trailers max total weight **1200 kg**
 and max vertical load **60 kg**.

From manufacturer

Thank you for buying our product. Their reliability has been confirmed in many tests. Reliability of towbar depends also on correct assembly and correct exploitation. For this reasons we kindly ask to read carefully this instruction and apply to hints.

The towbar should be install in points described by a car producer.

Torque settings for nuts and bolts (8,8):

M6 - 11 Nm	M8 - 25 Nm	M10 - 50 Nm
M12 - 87 Nm	M14 - 138 Nm	M16 - 210 Nm











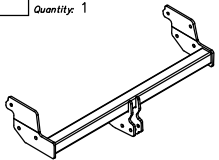
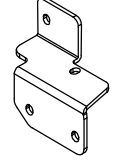

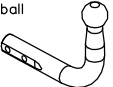
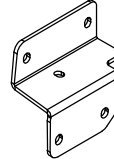

NOTE

After install the towbar you should get adequate note in registration book (at authorised service station).The car should be equipped with:

- Indicators
- Tow mirrors

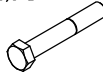
After 1000km of exploitation check all bolts and nuts. The ball of towbar must be always kept clear and conserve with a grease.

Towbar accessories:

Pos. 1 Name: Main bar Quantity: 1 	Pos. 5 Name: Right bracket Quantity: 1 	Pos. 8 Name: Bolt 8,8 B Quantity: 1 Dim.: M12x50mm 	Pos. 13 Name: Plain washer Quantity: 3 Dim.: Ø 13 mm 
Pos. 2 Name: Tow ball Quantity: 1 	Pos. 6 Name: Left bracket Quantity: 1 	Pos. 9 Name: Bolt 8,8 B Quantity: 4 Dim.: M10x40mm 	Pos. 14 Name: Plain washer Quantity: 12 Dim.: Ø 10,5 mm 
Pos. 3 Name: Socket plate Quantity: 1 	Pos. 10 Name: Bolt 8,8 B Quantity: 8 Dim.: M10x1,25x30mm 	Pos. 11 Name: Nut 8 B Quantity: 3 Dim.: M12 	Pos. 15 Name: Spring washer Quantity: 3 Dim.: Ø 12,2 mm 
Pos. 4 Name: Cut washer Quantity: 1 	Pos. 7 Name: Bolt 8,8 B Quantity: 2 Dim.: M12x75mm 	Pos. 12 Name: Nut 8 B Quantity: 4 Dim.: M10 	Pos. 16 Name: Spring washer Quantity: 12 Dim.: Ø 10,2 mm 
		Pos. 17 Name: Ball cover Quantity: 1 	



PPUH AUTO-HAK S.J.

Produkcja Zaczepów Kulowych
Henryk & Zbigniew Nejman
76-200 SŁUPSK ul. Słoneczna 16K
tel/fax (059) 8-414-414; 8-414-413
E-mail: office@autohak.com.pl
www. autohak.com.pl

Towing hitch (without electrical set)

Class: **A50-X** Cat. no. **Z30**

Designed for:

Manufacturer: **MITSUBISHI**

Model: **LANCER**

Type: **ESTATE**

produced since 06.2003 till 2008

Technical data:

D-value: 7,12 kg

maximum trailer weight: **1200 kg**

maximum vertical cup load: **60 kg**

Approval number acc. to regulations EKG/ONZ 55.01: **E20-55R-01 1060**

Foreword

This towing hitch is designed according to rules of safety traffic regulations. The towing hitch is a safety component and can be install only by qualified personnel. Any alteration or conversion of the towing hitch is prohibited and would lead to cancellation of design certification. Remove insulating compound and underseal from vehicle (if present) in the areas of the matting surfaces of the towing hitch. The vehicle manufacturer's specifications regarding trailer load and max. vertical cup mass are decisive for driving whereat values for the towing hitch cannot be exceeded.

D-value formula:

$$\frac{\text{Max trailer weight [kg]} \times \text{Max vehicle weight [kg]}}{\text{Max trailer weight [kg]} + \text{Max vehicle weight [kg]}} \times \frac{9,81}{1000} = D \text{ [kN]}$$